



2N7002DW

60V N-Channel Enhancement Mode MOSFET

FEATURES

- $R_{DS(ON)}$, V_{GS} @ $10V$, I_{DS} @ $500mA=5\Omega$
- $R_{DS(ON)}$, V_{GS} @ $4.5V$, I_{DS} @ $75mA=7.5\Omega$
- Advanced Trench Process Technology
- High Density Cell Design For Ultra Low On-Resistance
- Specially Designed for Battery Operated Systems, Solid-State Relays Drivers : Relays, Displays, Lamps, Solenoids, Memories, etc.
- In compliance with EU RoHS 2002/95/EC directives

MECHANICAL DATA

- Case: SOT-363 Package
- Terminals : Solderable per MIL-STD-750, Method 2026
- Marking : 702

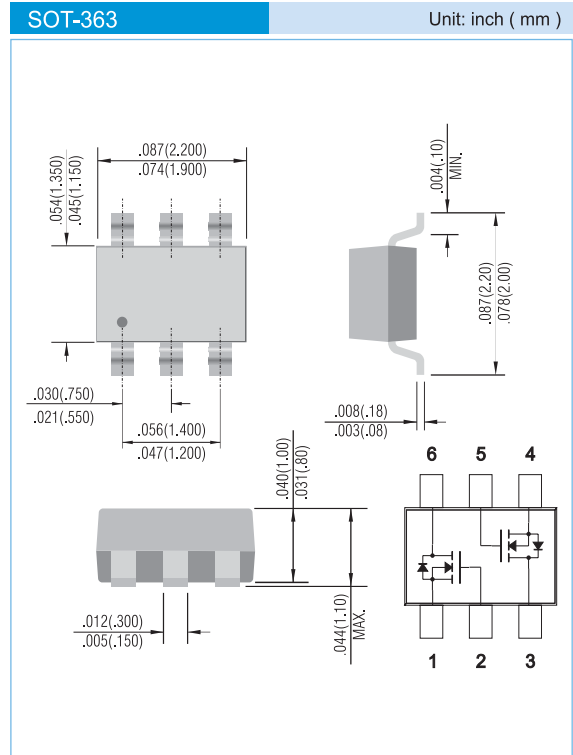

Maximum RATINGS and Thermal Characteristics ($T_A=25^\circ\text{C}$ unless otherwise noted)

PARAMETER	Symbol	Limit	Units
Drain-Source Voltage	V_{DS}	60	V
Gate-Source Voltage	V_{GS}	± 20	V
Continuous Drain Current	I_D	115	mA
Pulsed Drain Current ¹⁾	I_{DM}	800	mA
Maximum Power Dissipation	P_D	200 120	mW
Operating Junction and Storage Temperature Range	T_J, T_{STG}	-55 to + 150	$^\circ\text{C}$
Junction-to Ambient Thermal Resistance(PCB mounted) ²	$R_{\theta JA}$	625	$^\circ\text{C/W}$

- Note: 1. Maximum DC current limited by the package
2. Surface mounted on FR4 board, $t \leq 10$ sec

PAN JIT RESERVES THE RIGHT TO IMPROVE PRODUCT DESIGN,FUNCTIONS AND RELIABILITY WITHOUT NOTICE



2N7002DW

ELECTRICAL CHARACTERISTICS

Parameter	Symbol	Test Condition	Min.	Typ.	Max.	Units
Static						
Drain-Source Breakdown Voltage	BV_{DSS}	$V_{GS}=0V, I_D=10\mu A$	60	-	-	V
Gate Threshold Voltage	$V_{GS(th)}$	$V_{DS}=V_{GS}, I_D=250\mu A$	1	-	2.5	V
Drain-Source On-State Resistance	$R_{DS(on)}$	$V_{GS}=4.5V, I_D=75mA$	-	-	7.5	Ω
Drain-Source On-State Resistance	$R_{DS(on)}$	$V_{GS}=10V, I_D=500mA$	-	-	5	
Zero Gate Voltage Drain Current	I_{DSS}	$V_{DS}=60V, V_{GS}=0V$	-	-	1	μA
Gate Body Leakage	I_{GSS}	$V_{GS}=\pm 20V, V_{DS}=0V$	-	-	± 100	nA
Forward Transconductance	g_{fs}	$V_{DS}=15V, I_D=250mA$	200	-	-	mS
Dynamic						
Total Gate Charge	Q_g	$V_{DS}=15V, I_D=500mA$ $V_{GS}=4.5V$	-	0.6	0.7	nC
Gate-Source Charge	Q_{gs}		-	0.1	-	
Gate-Drain Charge	Q_{gd}		-	0.08	-	
Turn-On Delay Time	t_{on}	$V_{DD}=10V, R_L=20\Omega$ $I_b=500mA, V_{GEN}=10V$ $R_G=10\Omega$	-	9	15	ns
Turn-Off Delay Time	t_{off}		-	21	26	
Input Capacitance	C_{iss}	$V_{DS}=25V, V_{GS}=0V$ $f=1.0MHz$	-	-	50	pF
Output Capacitance	C_{oss}		-	-	25	
Reverse Transfer Capacitance	C_{rss}		-	-	5	
Source-Drain Diode						
Max. Diode Forward Current	I_s	-	-	-	250	mA
Diode Forward Voltage	V_{SD}	$I_s=250mA, V_{GS}=0V$	-	0.93	1.2	V

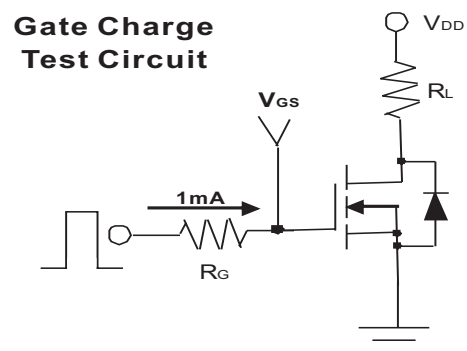
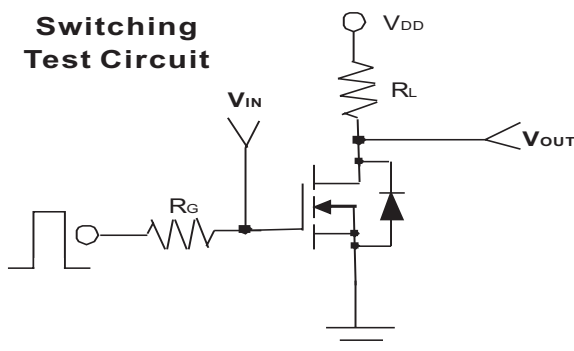



2N7002DW

Typical Characteristics Curves ($T_J=25^\circ\text{C}$, unless otherwise noted)

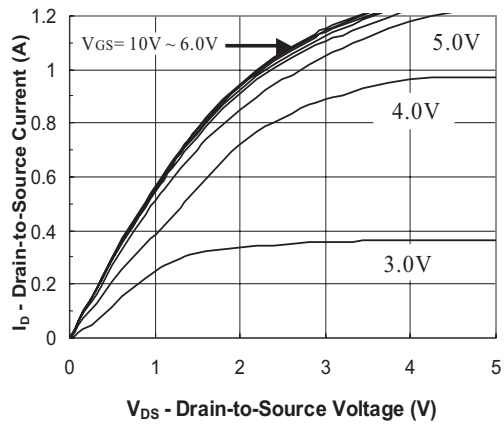

FIG.1- Output Characteristic

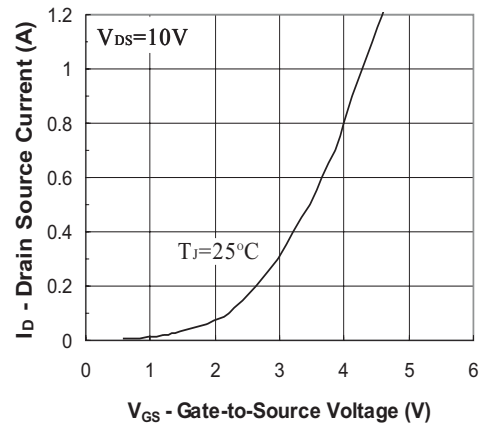

FIG.2- Transfer Characteristic

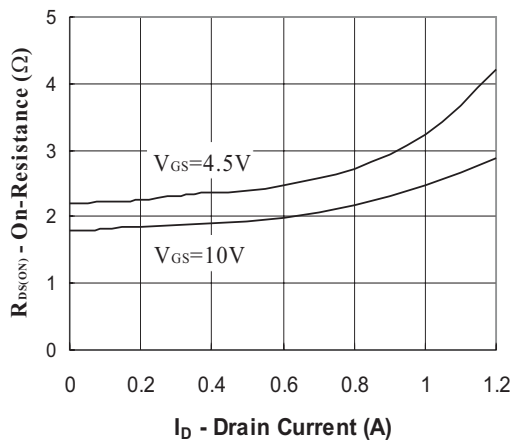

FIG.3- On Resistance vs Drain Current

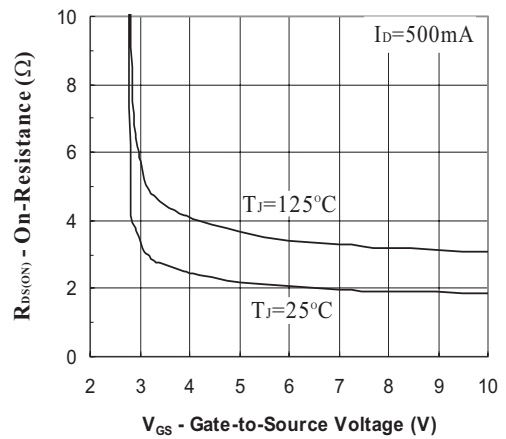

FIG.4- On Resistance vs Gate to Source Voltage

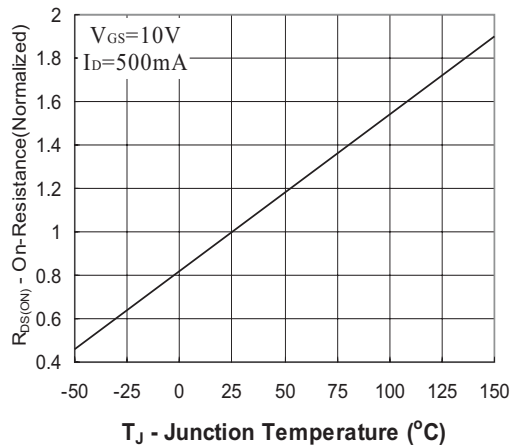

FIG.5- On Resistance vs Junction Temperature



2N7002DW

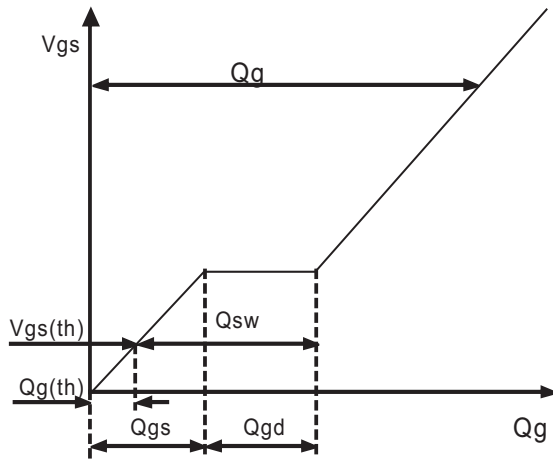

Fig.6 - Gate Charge Waveform

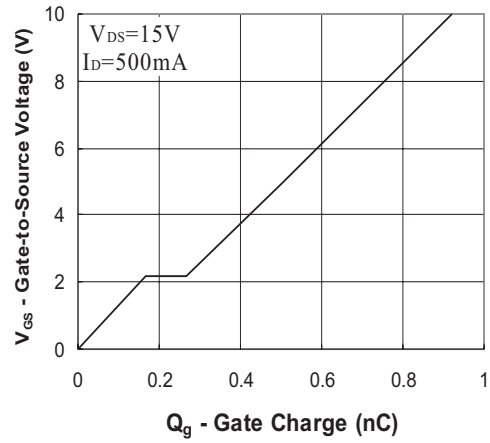

Fig.7 - Gate Charge

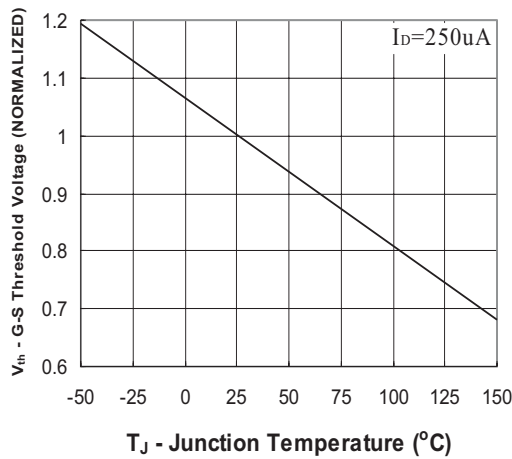

Fig.8 - Threshold Voltage vs Temperature

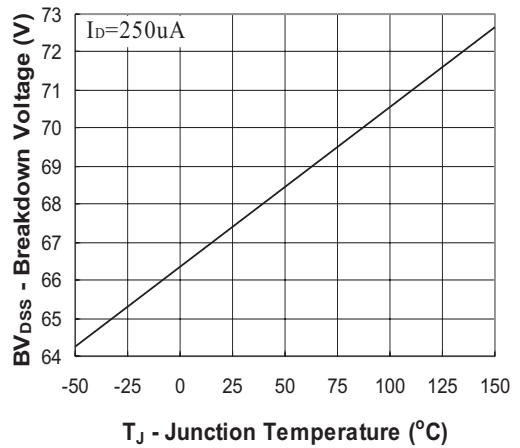

Fig.9 - Breakdown Voltage vs Junction Temperature

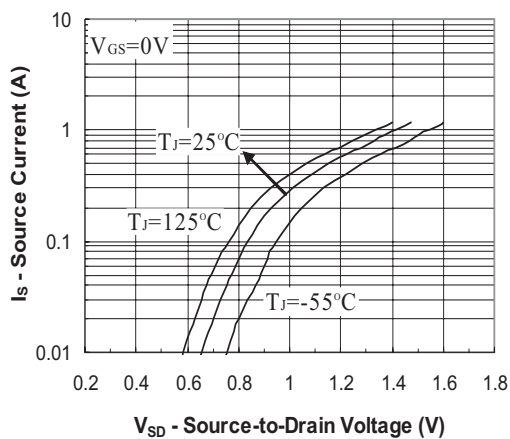
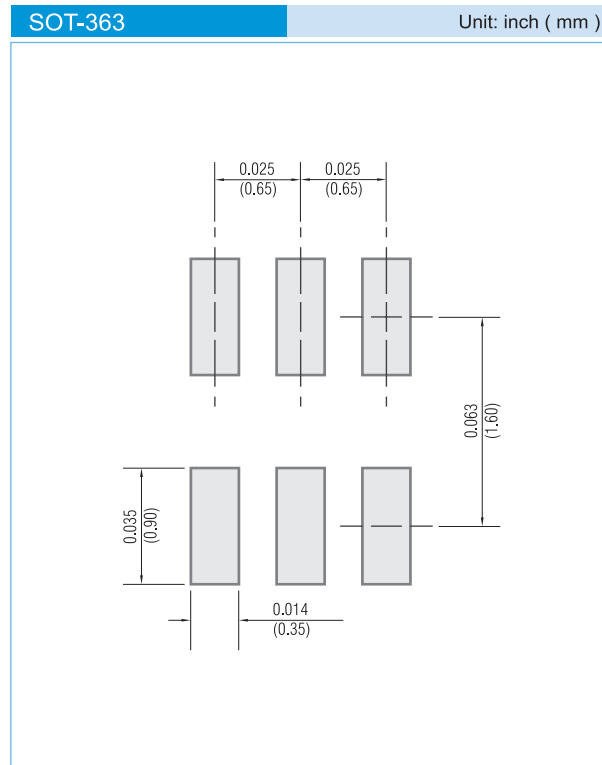

Fig.10 - Source-Drain Diode Forward Voltage



2N7002DW

MOUNTING PAD LAYOUT



ORDER INFORMATION

- Packing information
 - T/R - 10K per 13" plastic Reel
 - T/R - 3K per 7" plastic Reel

LEGAL STATEMENT

Copyright PanJit International, Inc 2007

The information presented in this document is believed to be accurate and reliable. The specifications and information herein are subject to change without notice. Pan Jit makes no warranty, representation or guarantee regarding the suitability of its products for any particular purpose. Pan Jit products are not authorized for use in life support devices or systems. Pan Jit does not convey any license under its patent rights or rights of others.